

IDM UID <b>V89YJN</b>
VERSION CREATED ON / VERSION / STATUS <b>06 Oct 2017 / 2.0 / Signed</b>
EXTERNAL REFERENCE / VERSION

## Technical Specification

# Technical Summary for TCC0

Global overview of the scope for TCC0 contract

<i>Approval Process</i>			
	<i>Name</i>	<i>Action</i>	<i>Affiliation</i>
<i>Author</i>	<b>Kotamaki M.</b>	<b>09 Oct 2017:signed</b>	<b>IO/DG/COO/CST/TCS</b>
<i>Co-Authors</i>	<b>Rafin L.</b>	<b>06 Oct 2017:signed</b>	<b>IO/DG/RCO/FPD/PCD</b>
	<b>Targa R.</b>	<b>06 Oct 2017:signed</b>	<b>IO/DG/COO/CST/TCS</b>
<i>Reviewers</i>			
<i>Approver</i>	<b>Murphy S.</b>		<b>IO/DG/COO/CST/TCS</b>
<i>Document Security: Internal Use</i> <i>RO: Kotamaki Miikka</i>			
<i>Read Access</i>	<b>LG: Contract/Finance for CMA, LG: TCC1 Tender Project Team , AD: IO_Director-General, AD: EMAB, AD: OBS - Tokamak Complex Section Division (TCS), AD: OBS - Construction Management Division (CMG), AD: Auditors, project administrator, RO</b>		

*Change Log*

**Technical Summary for TCC0 (V89YJN)**

<i>Version</i>	<i>Latest Status</i>	<i>Issue Date</i>	<i>Description of Change</i>
v0.0	In Work	29 Sep 2017	
v1.0	In Work	29 Sep 2017	First version
v1.1	Approved	29 Sep 2017	Solving layout/format issues
v2.0	Signed	06 Oct 2017	Alignment of the technical summary with the procurement summary of TCC0 contract

## Table of Contents

<b>1</b>	<b>PURPOSE .....</b>	<b>2</b>
<b>2</b>	<b>ABBREVIATIONS .....</b>	<b>2</b>
<b>3</b>	<b>GENERAL STATEMENT .....</b>	<b>3</b>
3.1	STAGED APPROACH .....	3
3.2	CONSTRUCTION AREAS .....	4
3.3	STRUCTURE .....	5
3.4	SCOPE OF ACTIVITIES.....	5
3.5	STEPS IN BIDDING FOR THE CONTRACTS.....	7
3.6	CONTRACT SUPERVISION.....	7
<b>4</b>	<b>INTERFACES AND RESOURCES.....</b>	<b>8</b>
4.1	BOUNDARY BETWEEN WORKSITE 1 AND WORKSITE 2.....	8
4.2	WORKSHOPS.....	8
4.3	INTERFACES TO OTHER CONTRACTS .....	9
4.3.1	<i>Interfaces to IO WS2 Contractors .....</i>	<i>9</i>
4.3.2	<i>Scaffolding.....</i>	<i>9</i>
4.3.3	<i>Lifting .....</i>	<i>9</i>
<b>5</b>	<b>REQUIRED COMPETENCES .....</b>	<b>10</b>
	<b>ANNEX I.1. WORKSITE 2 AND BUILDINGS RELEVANT FOR THE SCOPE OF THE TCC0 CONTRACT .....</b>	<b>12</b>
	<b>ANNEX I.2. SUMMARY OF QUANTITIES FOR TCC0 CONTRACT .....</b>	<b>13</b>

## 1 Purpose

The purpose of this document is to provide a high level definition of the scope of works and required Contractor competences for the Tokamak Complex Contract 0 (TCC0), covering the first part of the assembly works for the Tokamak Complex, also known as Worksite 2 of the ITER Project based in Saint Paul Lez Durance, France.

This document summarises the scope and strategy for the TCC0, details the essential expertise, experience and skills required of the TCC0 Contractor, hereinafter referred to “Contractor”, and provides a brief description of the works organisation

## 2 Abbreviations

The following table lists and defines the abbreviations used in this document.

Abbreviation	Definition
ASN	Autorité de Sûreté Nucléaire
CCWS	Component Cooling Water System
CHWS	Chilled Water System
CMA	Construction Management as Agent
CWP	Construction Work Package
DA	Domestic Agency
E&IC	Electrical, Instrumentation and Control
ESPN	Equipements Sous Pression Nucléaire (Nuclear Pressure Equipment)
INB	Installation Nucléaire de Base (Basic Nuclear Installation)
IO	ITER Organization
IWP	Installation Work Package
M&P	Mechanical & Piping
NDT	Non Destructive Testing
PIA	Protection Important Activities
TAC	Tokamak Assembly Contract
TBM	Test Blanket Modules System
TCC	Tokamak Complex Contract
TCWS	Tokamak Cooling Water System
WS	Worksite

**Table 1** - Abbreviations and Acronyms

### 3 General Statement

#### 3.1 Staged approach

Assembly of the ITER Tokamak is separated into four distinct phases; and the timeline for the first two Tokamak Assembly Phases is shown in Figure 1.

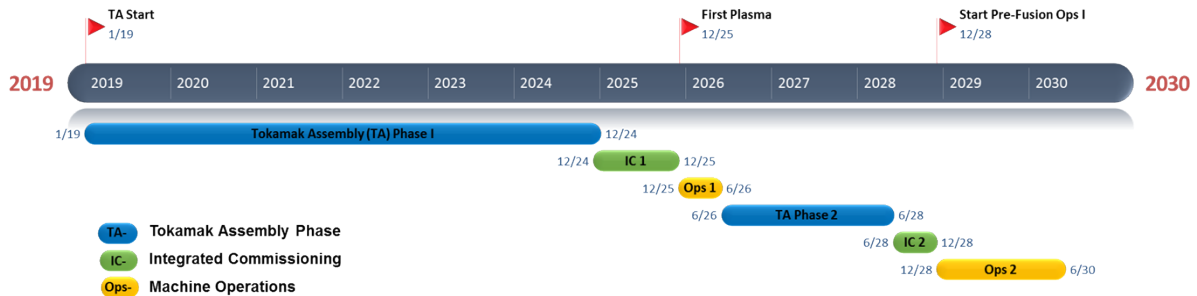

Figure 1. Assembly Phases

- **Assembly Phase 1** includes the basic Tokamak machine with systems essential for First Plasma operation; the installations comprise permanent hardware, temporary equipment replacing permanent hardware, such as the main in-vessel components, and captive components that cannot be installed in later assembly phases.
- **Assembly Phase 2** includes the installation of the main in-vessel components, including the Blanket, the Divertor and coils. Heating systems will be installed and diagnostics systems will be added to support the research program. Preparatory activities for Assembly Phase 2 will occur during Assembly Phase 1. The contract strategy for this phase will be defined later.

The ITER Organization (IO) is already in the process of tendering for the Assembly Phase 1.

For Worksite 2, the IO plans to award three contracts TCC0, TCC1 and TCC2, to cover the whole scope of the Assembly Phase 1; the scope of these Contracts will cover all the Mechanical & Piping (M&P) and Electrical, Instrumentation and Control (E&IC) installation works of this area. This technical summary covers the TCC0 contract only.

### 3.2 Construction Areas

The works in the scope of the Contract are located on the ITER Platform currently under construction in Cadarache, Southern France. Central to the facility is the Tokamak Complex, a nuclear rated structure in reinforced concrete that comprises three integrated buildings, Figure 2. The Complex has a footprint of 118 x 81 m, extends vertically from -15 m to +40 m relative to ground level, and contains the plant systems that service (power, heat, cool, condition, fuel, monitor and control) the Tokamak machine.,:

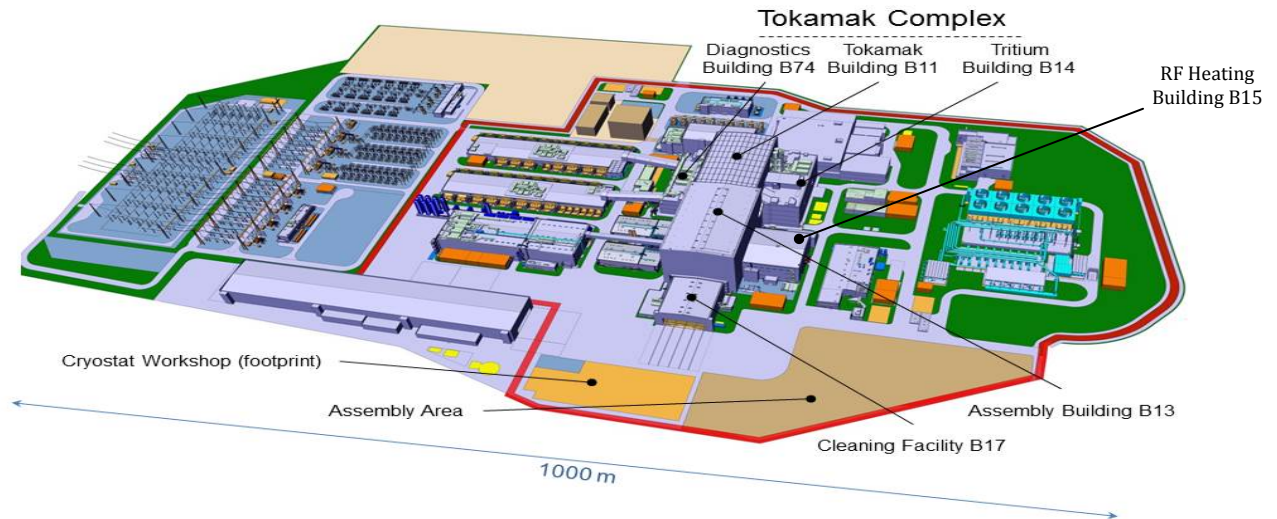

Figure 2. Site Overview – Future Final Configuration

The ITER site has been divided into 5 independent main worksites (WS). The worksites are defined to collect together groups of buildings and areas by major discipline, in order to better allocate works Contractors and suitably qualified persons. As presented in the Figure 3 below, the breakdown of the site and works is the following:

- WS1 - Tokamak Basic Machine (including Assembly and Cleaning Facility buildings)
- WS2 - Tokamak Complex buildings (excluding Tokamak Pit)
- WS3 - Other nuclear buildings and Control building
- WS4 - Cryogenic plant and Site Services buildings
- WS5 - Electrical Areas and Power Supplies Buildings

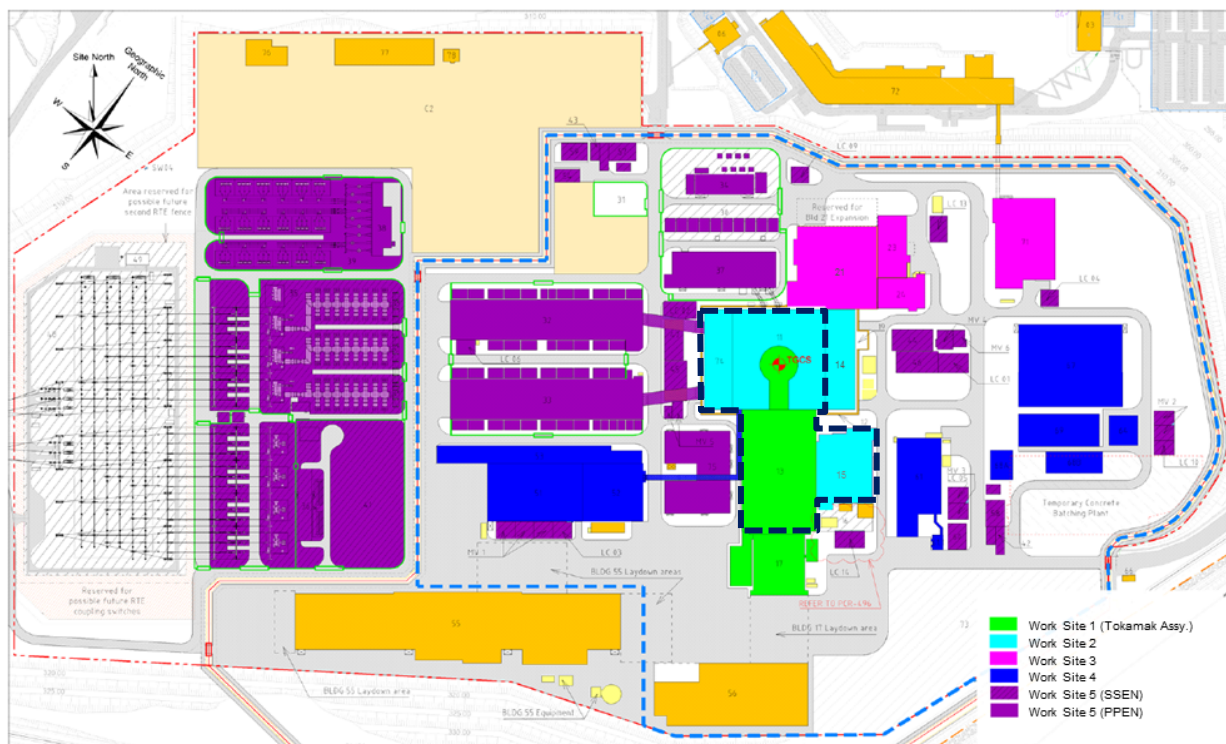

Figure 3. Breakdown of the ITER Site and buildings to independent Construction Worksites.

The works in the scope of the Contract will take place in the WS2 and partially in the WS1 in the buildings indicated with dashed black line in the Figure 3. These are:

- Building 11 – Tokamak Building
- Building 74 – Diagnostic Building
- Building 15 – RF Heating Building

In addition, some minor works in the scope of the Contract are located in the Tokamak Assembly Hall (building 13) which belongs to the Worksite 1.

### 3.3 Structure

The IO, assisted by the Construction Manager as-Agent (CMA), will define the assembly process through Construction Work Packages (CWPs). Each CWP will define a package of works prepared and instructed to the Contractor by the CMA and performed by the Contractor as a unit, with a defined start and completion point and a required cost based upon the tendered unit rates for each type of work.

The full work scope of TCC0 will involve about 60 CWPs divided in three lots. See Annex I for the detail description of each lot.

### 3.4 Scope of activities

The contract will include, but not limited to, the installation of the Phase 1 configuration of the following plant systems: Component and Chilled Cooling Water, Fuelling, Vacuum, Tritium and Test Blanket Modules.

The scope of this contract includes various activities such as:

- Construction execution documentation to properly perform the construction works,
- All the necessary documentation required to undertake and to follow-up installation activities and to record and trace all activities (as built dossier),
- Pre-manufacturing and Installation of pipe spools including related supports and insulation,
- Installation of pre-manufactured pipe spools and other related items procured by ITER Domestic Agencies (DA),
- Installation of specific systems requiring special cleanliness, techniques or accuracy (e.g. fuelling lines, vacuum lines),
- Pre-manufacturing and Installation of pipe spools including related supports according to the ESPN regulation,
- Installation Tests (e.g. NDT, pressure test, leak tests and vacuum tests),
- Preservation works,
- Finishing works (e.g. internal cleaning, touch-up paint, thermal insulation, cladding, labelling and tagging),

The Contractor shall also be responsible for the following items:

- Provide any required temporary works including, but not only, the means of protection and the tools needed to properly manage and perform the different stages of work in the buildings and on site,
- The Contractor will be responsible for defining the scaffolding needs. The IO will provide the needed scaffolding through a service contractor while the CMA will coordinate the services.
- Minor lifting and handling equipment required for the installation of the described items in Annex I.
- Issue all necessary documentation for the works such as, but not limited to, Quality Plan, Health and Safety plan, workforce planning (Installation sequence and Level 4 Schedule) and the List of documents to be issued for the execution of the works.
- Provide the records of NDT's and all the information required to comply with regulation and applicable codes,
- Perform final installation tests (mechanical completion) and verifications at the mechanical completion of the Structural, Mechanical & Piping including:
  - Verification that the piping systems, mechanical equipment and their supporting structure are correctly installed
  - Non-destructive examination
  - Hydrostatic tests
  - Technical cleaning (foreign material exclusion, dust control, flushing or others)

The required areas of expertise for the above activities are defined in Section 5 and Annex I.



For some horizontal activities (e.g. handling, lifting, scaffolding, transport) the Contractor shall have to interface with the companies awarded for these specific activities. The interfaces will be managed by the CMA under the surveillance of the IO.

As well as planned CWP's the IO may define additional work packages to implement modifications to components, tools or processes, or to implement corrective actions. These will be agreed with the contractors in advance.

## 4 Interfaces and Resources

### 4.1 Boundary between Worksite 1 and Worksite 2

As described in section 3.2 and in figure 3 the works in the scope of the Contract take place in Worksite 2 (WS2) which includes Tokamak building 11. The physical boundary of the Tokamak Machine inside building 11 is, for the purpose of assembly and installation works, defined by the outer surface of the bio-shield, indicated with red circle in figure 4. In general terms, this surface demarcates the Tokamak machine assembly works to be executed by the TAC Contractors (WS1) from the Tokamak Complex plant installation works to be executed by the TCC Contractors and others (WS2).

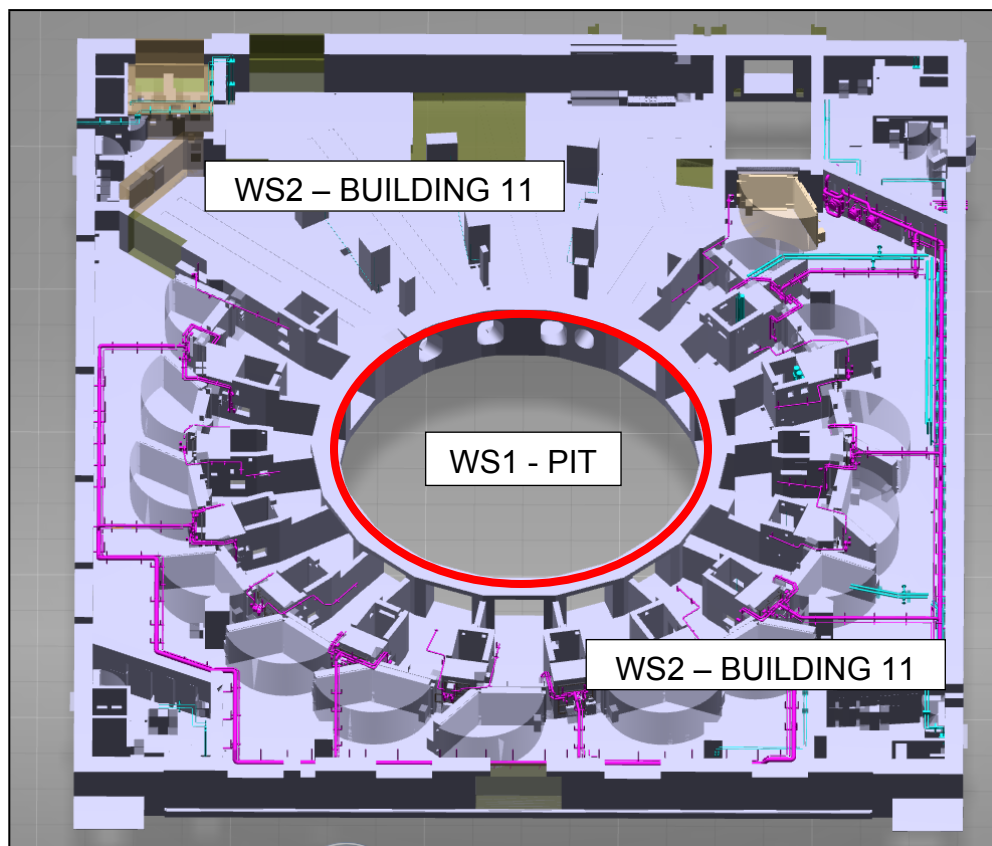

Figure 4. Physical boundary principle between WS1 and WS2 in the Building 11

## 4.2 Workshops

The IO will provide an area dedicated to the Contractor for the installation of his site facilities, possibly covering a workshop, local storage, and some pre-assembly activities on smaller components. These areas will be located on the ITER Worksite platform. The areas will be connected to the potable water, IT and electrical networks as well as to the industrial drainage network.

To support the pre assembly activities, the Contractor shall provide a general workshop facility within the area described above and as appropriate to volume and schedule an off-site locally workshop to enable the pre fabrication and modification of pipe spools, steel structure, supports, insulation, temporary meanings, etc. These workshops shall be staffed by competent technicians, and have an acceptable selection of hand tools, machine tools, control instrumentation and welding equipment. Part of these workshops shall be segregated for carbon and stainless steel fabrication.

The contractor will be fully responsible for transport between the ITER site and these workshops, and for any ITER components while off-site.

On the site, ITER has available a number of buildings for component storage. In general IO tools and components will be collected by the Contractor from these storage locations, and returned to them on completion of the corresponding CWP.

## 4.3 Interfaces to Other Contracts

### 4.3.1 *Interfaces to IO WS2 Contractors*

The Contractor may:

- Execute a CWP where the preceding CWP was performed by another contractor;
- Complete a CWP where the following CWP is performed by another contractor;

At the start of a CWP the Contractor will have an opportunity to examine and accept the components/environmental conditions, and at the end of the works, the completion will be certified by the IO with the support of the CMA.

### 4.3.2 *Scaffolding*

The IO will put in place a framework contract for the lease of scaffolding (scaffolding contractor). This contract will be for the provision of scaffolding to the Contractor and other IO works contractors.

Due to the high level of interaction between different contractors, the use of this scaffolding contract will be obligatory for all work being carried out in WS2 as several works contractors may use the same scaffolding. IO will pay the scaffolding contractor directly.

### 4.3.3 *Lifting*

In order to avoid that each Works Contractor places a separate subcontract for the hire of lifting equipment (mainly mobile cranes), IO had envisaged the obligatory use of a single contractor throughout the ITER Site (excluded Contractors areas and workshops).

The use of this framework contract shall be obligatory for the IO Contractors working in WS2. The IO will pay the lifting contractor directly but the responsibility for the lifting operation shall remain with the Contractor.

## 5 Required Competences

The competence and experience of the Contractor, and the ability, experience, and training of his engineering and construction team will have a direct influence on quality, re-work, and schedule, and ultimately on the performance of the Tokamak during operation; the Contractor will be required to demonstrate competence and experience in a number of key areas as listed in Table 2.

Area of Competence
Codes and Standards
Occupational Safety
Process Development and Qualification
Quality Assurance / Quality Control
Regulated construction
Process piping and equipment installation
Nuclear Pressure Equipment regulation
Vacuum pipes installation
Multi core pipes installation
Carbon and stainless steel welding process
Inspection and Non-Destructive Examination
Instrumentation Installation
Lifting and Handling
Tooling Maintenance, Storage and Preservation

**Table 2.** Required Competences

***ANNEX I***

***Tokamak Complex Installation Works  
TCC0 Contract***

***Overview of Scope of Work***

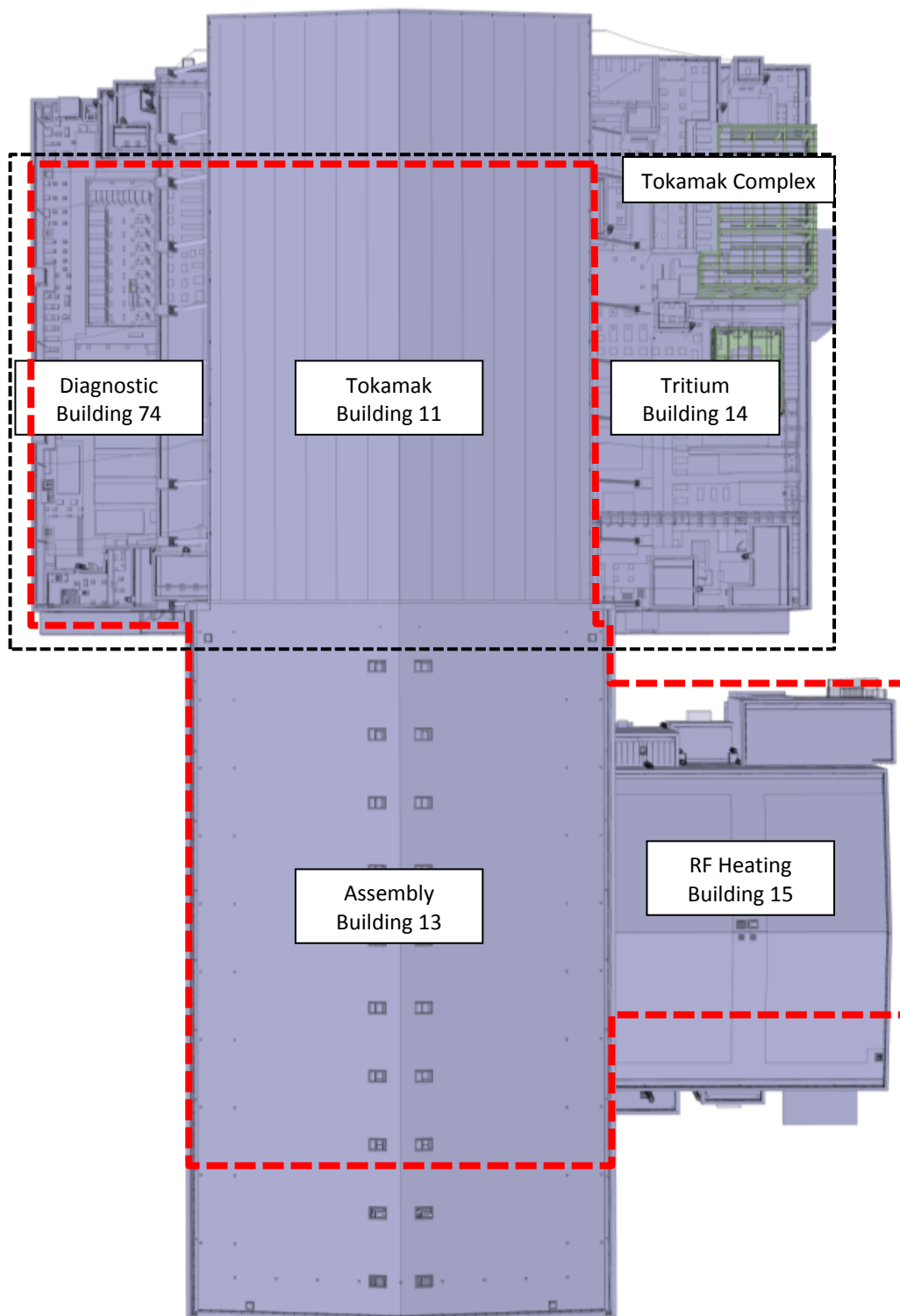

**Annex I.1. Worksite 2 and buildings relevant for the scope of the TCC0 Contract**

Figure A1. Buildings relevant for the scope of the Contract.

## Annex I.2. Summary of Quantities for TCC0 Contract

### Cooling Water System

Building	Item	Qty	Unit	Material	Max. Size	Lot	Remarks
B11 (Levels B2/B1/L1/L2)	Pipe	5000	m	304L	DN300	Lot 1&3	
	Valve	750	each	304L		Lot 1&3	
	Support	35	Ton	CS		Lot 1&3	
B13	Pipe	500	m	304L	DN500	Lot 2	Include 60pcs prefabricated spools
	Valve	100	each	304L		Lot 2	
	Support	3	Ton	CS		Lot 2	
B15	Pipe	1000	m	304L	DN700	Lot 2	Include 200pcs prefabricated spools
	Valve	250	each	304L		Lot 2	
	Support	25	Ton	CS		Lot 2	
B74 (Levels B2/B1/L1/L2)	Pipe	1300	m	304L	DN300	Lot 2	
	Valve	350	each	304L		Lot 2	
	Support	10	Ton	CS		Lot 2	

### Gas Distribution System (GDS) Manifold – Multicore Gas Line

Building	Item	Qty	Unit	Material	Max. Size	Lot	Remarks
B11 (Levels B1/L2)	spool	40ca.	each	316 L (Process pipes & Outer jacket)	DN 250 (Outer jacket)	Lot 3	

### Tritium System pipes

Building	Item	Qty	Unit	Material	Max. Size	Lot	Remarks
B11 (Levels B2/B1/L1/L2)	Pipe	1800	m	Stainless steel	DN300	Lot 1	

### Vacuum System pipes

Building	Item	Qty	Unit	Material	Max. Size	Lot	Remarks
B11 (Levels B1/L1)	Pipe	2200	m	Stainless steel	DN300	Lot 3	

### TBM pipes

Building	Item	Qty	Unit	Material	Max. Size	Lot	Remarks
B11 (Levels L1/L2)	Pipe	850	m	Stainless steel	DN60	Lot 3	

Table A1. Summary of Quantities

# ***Lot 1***

*CCWS – CHWS – Tritium pipes  
captive supports in Bldg. 11*

## Lot 1 in Tokamak Building – Level B2

- Tritium pipes (pink)
- Cooling water pipes for CCWS 2A – CCWS 2B – CHWS H2 – CHWS H1 (light blue)

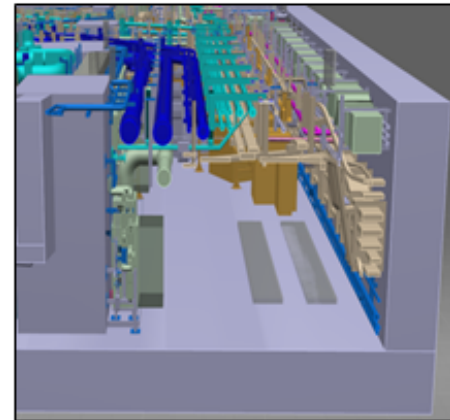
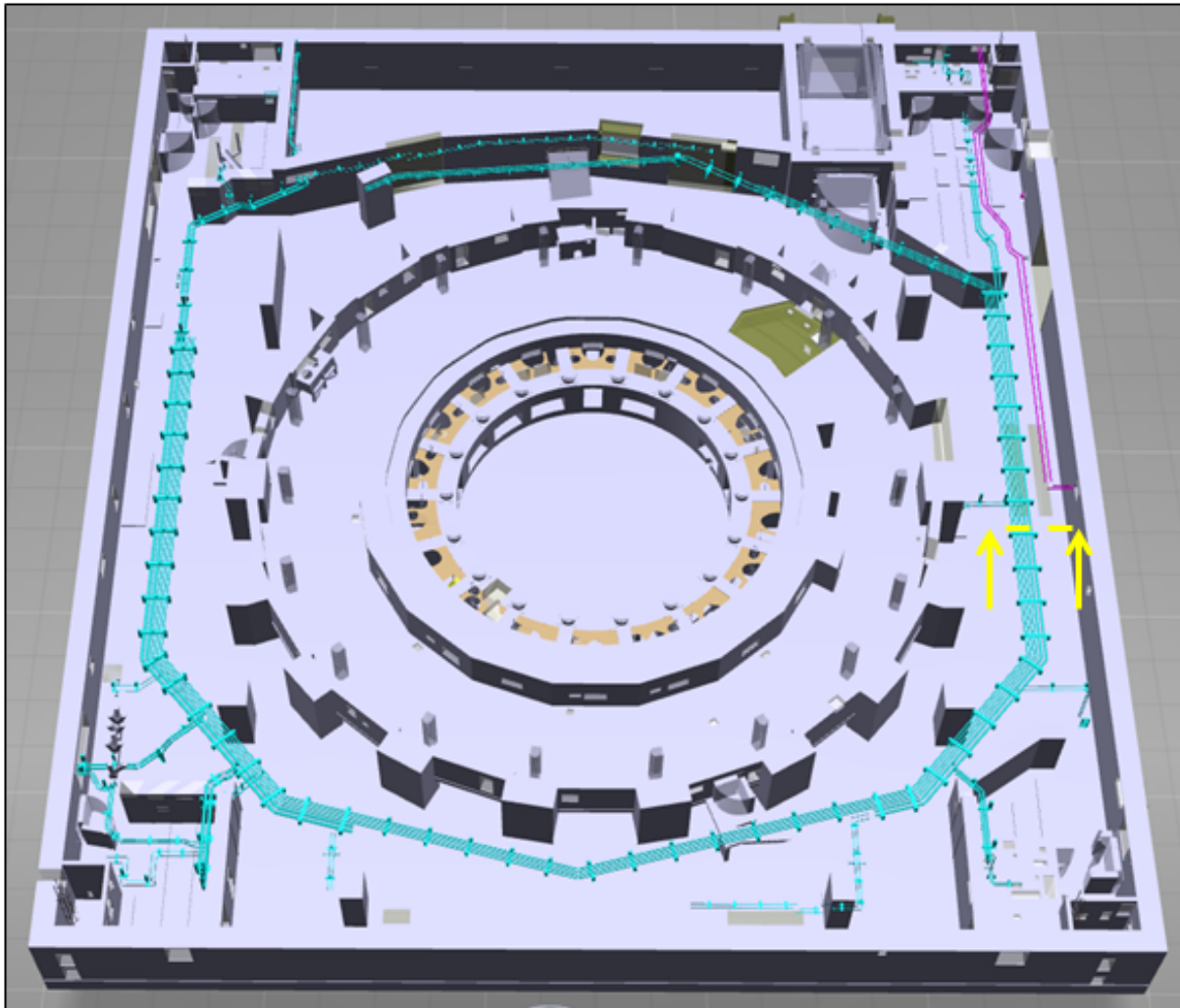

Gallery section view with the full environment

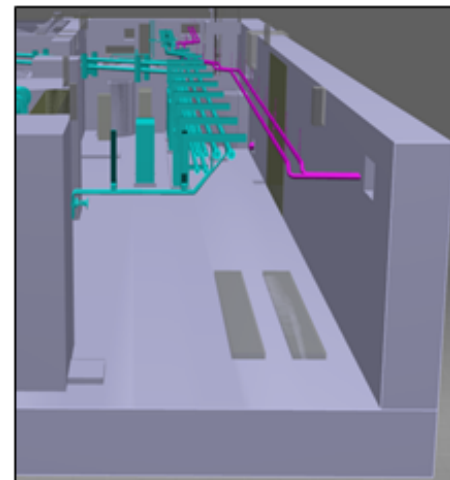

- Tritium pipes
- Cooling water

Gallery section view with TCCO scope only



## Tokamak Building 11 – Level B1

- Tritium pipes (pink)
- Cooling water pipes for CCWS-1 and for VV - CCWS 2A – CHWS H2 – CHWS H1 (light blue)

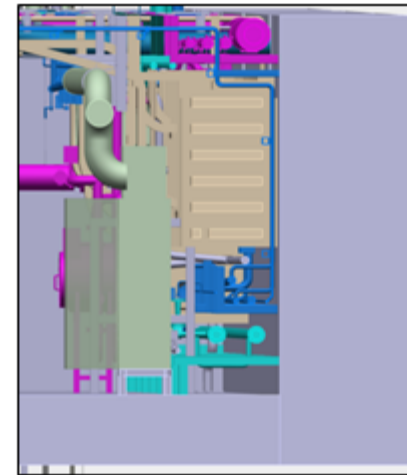
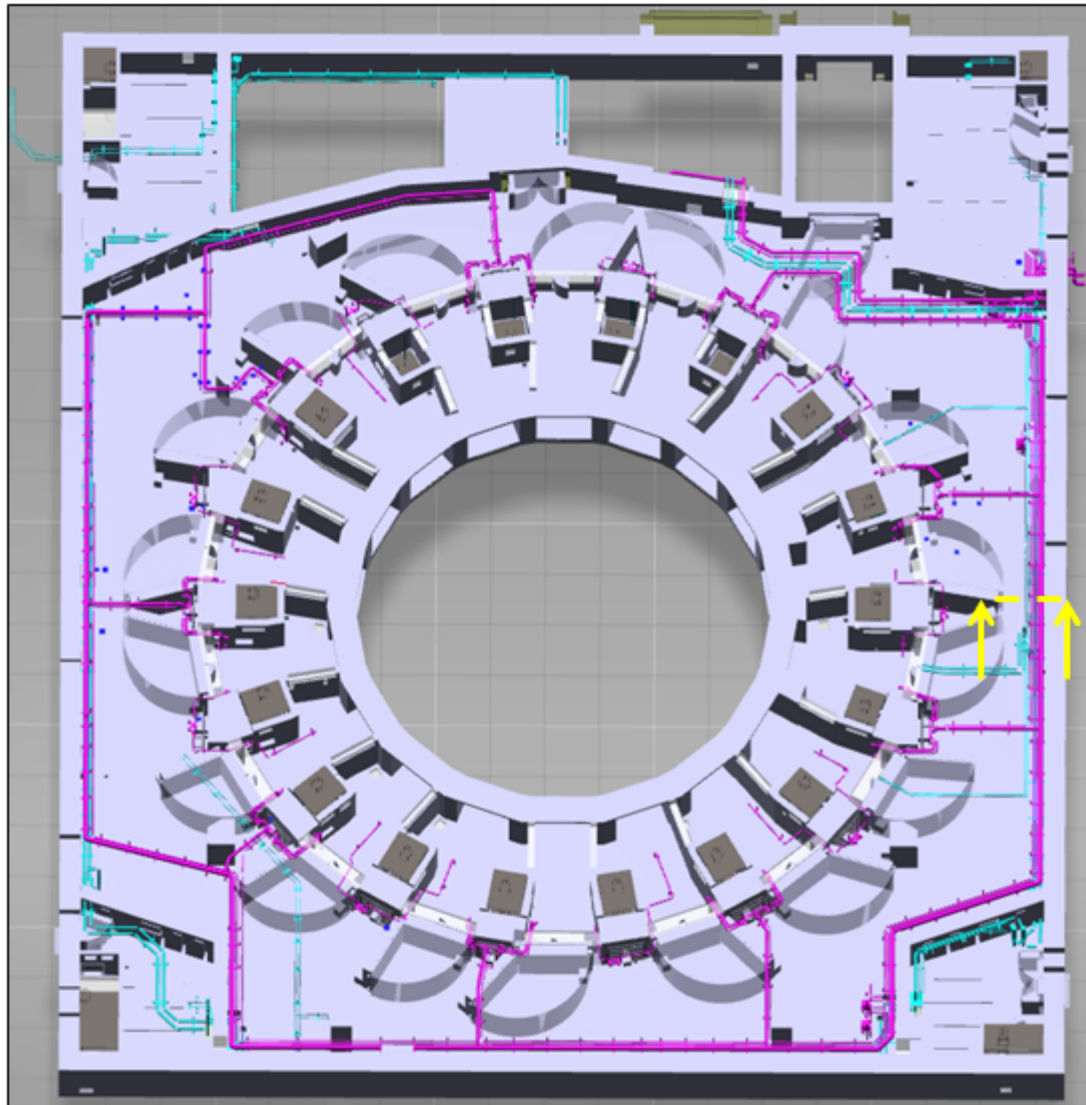

Gallery section view with full environment

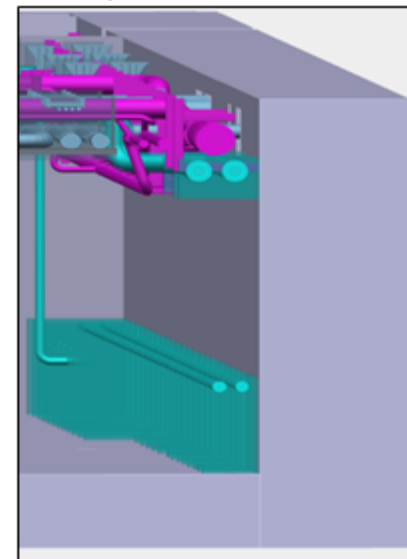

Gallery section view with TCCO scope only (all lots)

## Tokamak Building 11 – Level L1

- Tritium pipes (pink)
- Cooling water pipes for CCWS-1 and for VV - CCWS 2A – CHWS H2 – CHWS H1 (light blue)

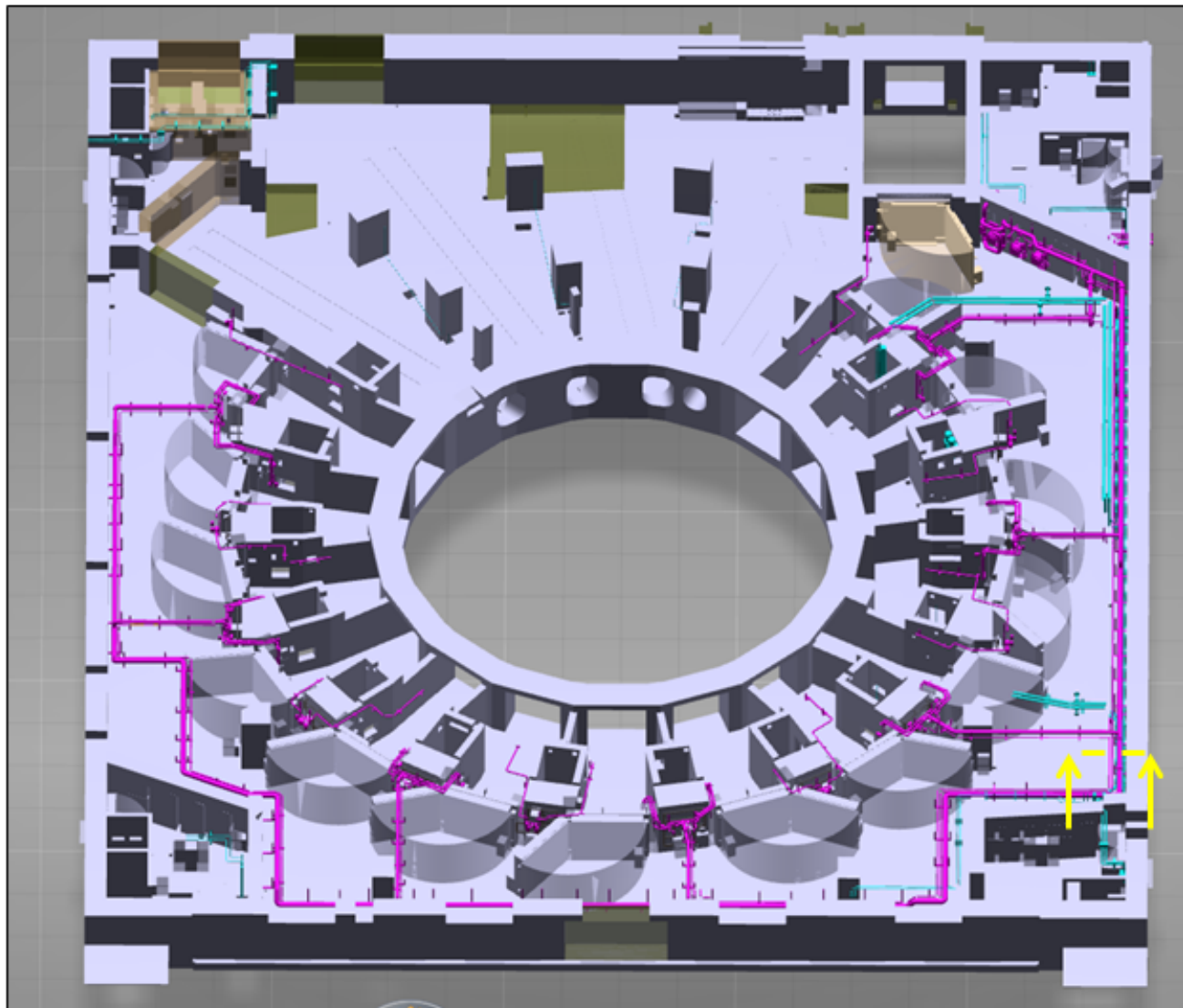

Gallery section view with full

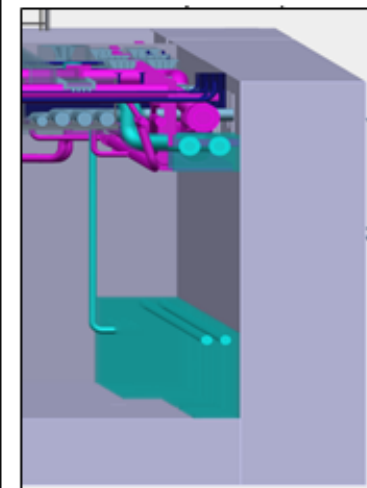

Gallery section view with TCCO scope only (all lots)

- Vacuum pipes
- TBM pipes
- Tritium pipes
- Cooling water

## Tokamak Building 11 – Level L2

- Tritium pipes (pink)
- Cooling water pipes for CCWS-1 and for VV - CCWS 2A – CHWS H2 – CHWS H1 (light blue)

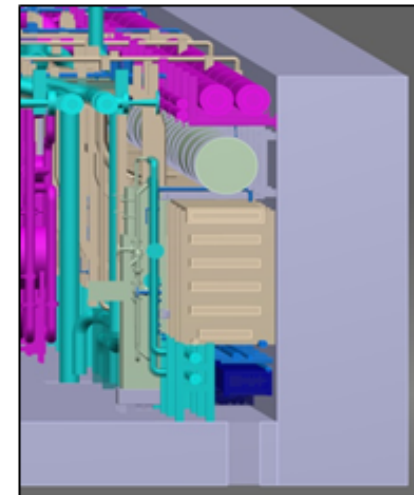
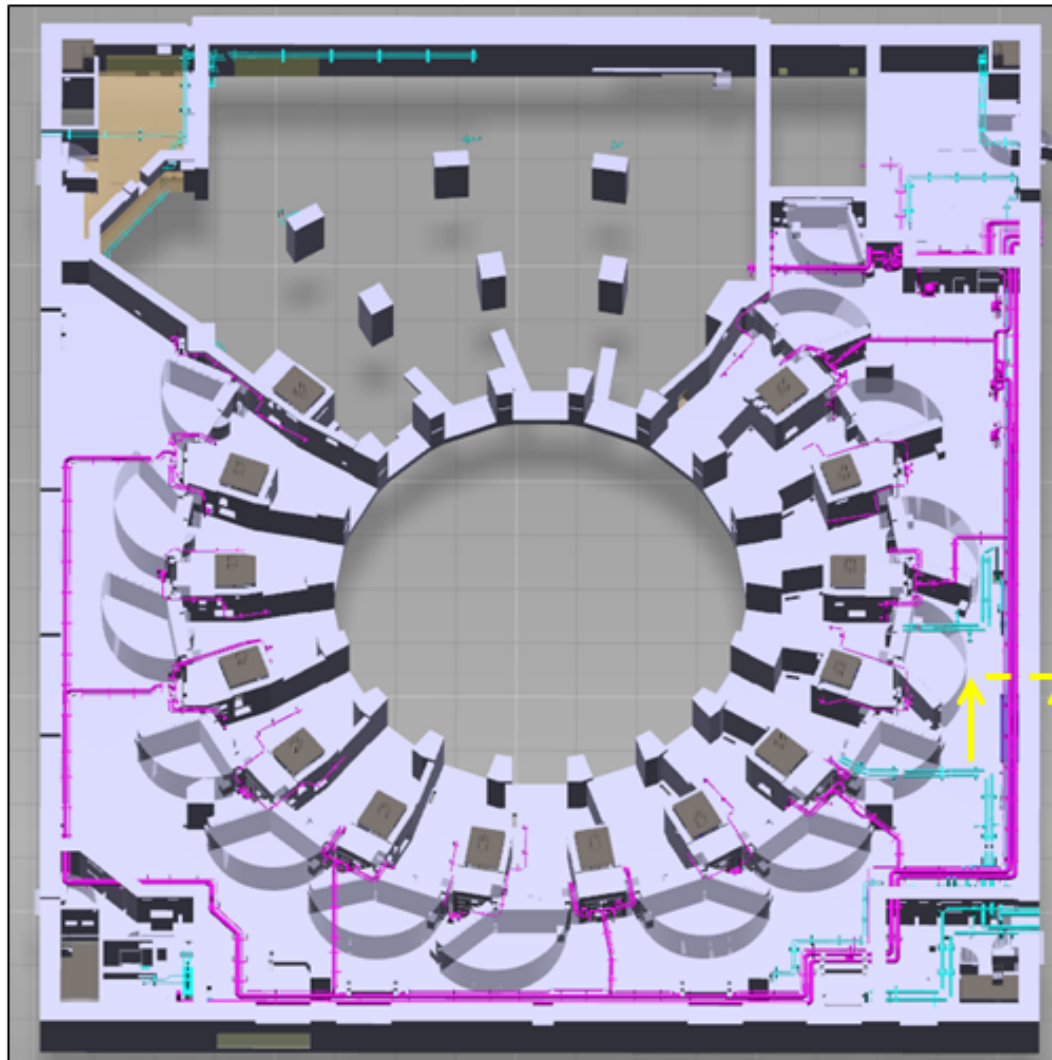

Gallery section view with full environment

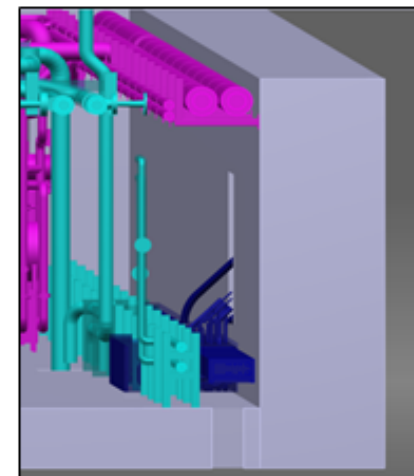

- TBM pipes
- Tritium pipes
- Cooling water

Gallery section view with TCCO scope only (all lots)

## ***Lot 1 Captive Supports***

The Lot 1 scope includes installation of some individual supports in congested areas with their upper section close to the ceiling or to the wall. The actual lines will be installed later but the supports typically need to be installed at early stage in sequence with the lines installed by other Worksite 2 contractors.

Note: this is a minor scope in terms of volume and complexity of installation.

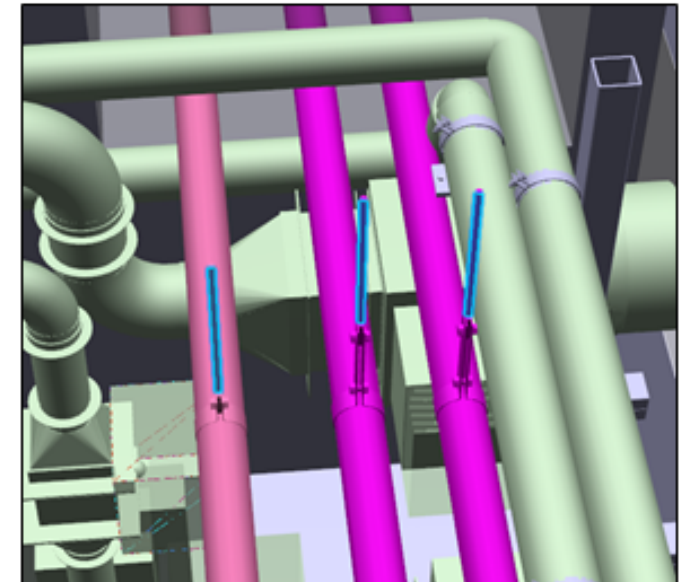
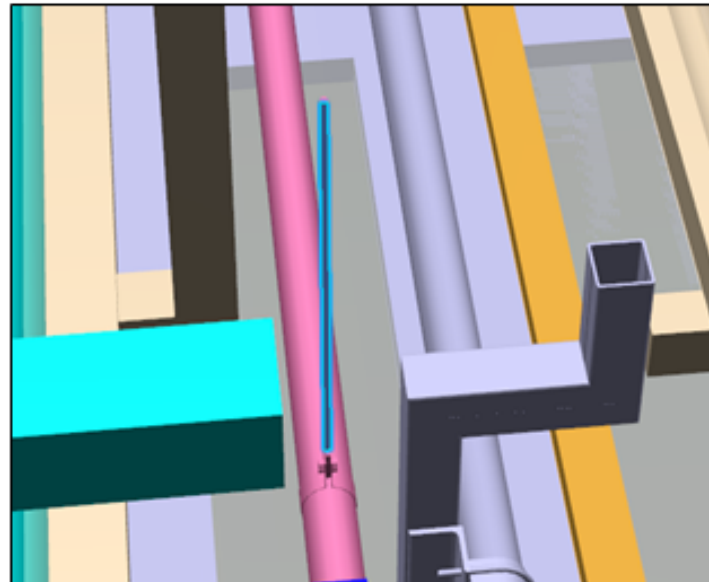
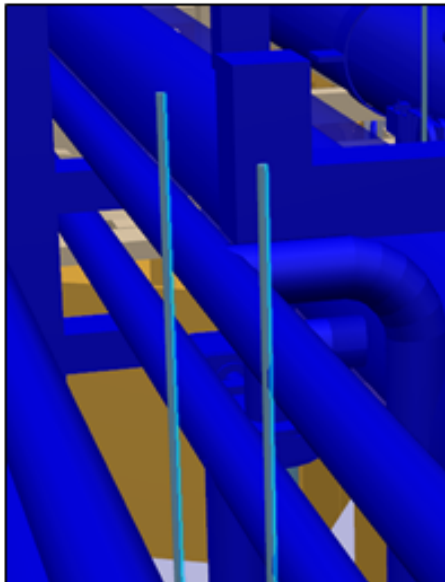

## ***Lot 2***

*Component and Chilled Cooling Water  
System (CCWS & CHWS) piping in  
Buildings 13, 15 and 74.*



## ***Lot 2 in Assembly Building 13***

■ Cooling water pipes for CCWS 2A – CCWS 2D

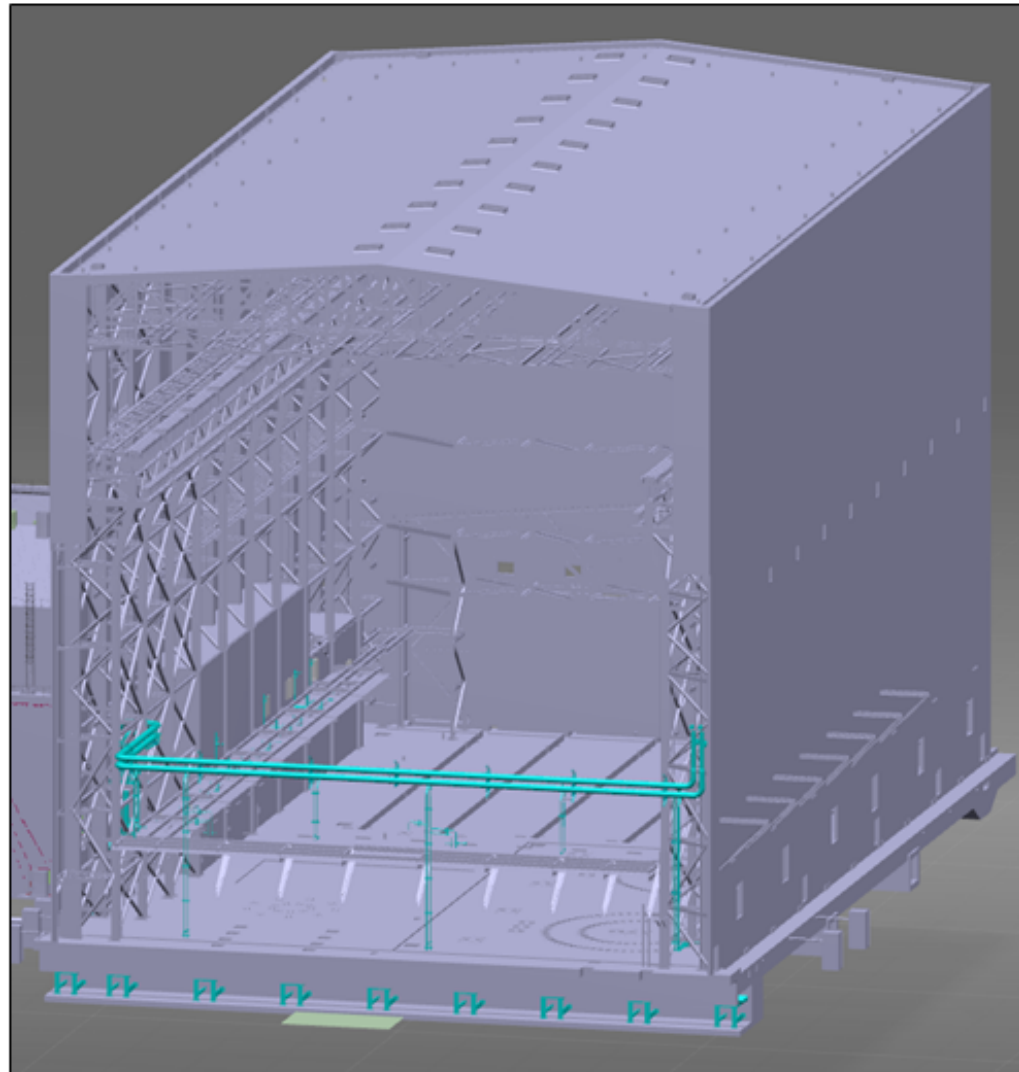

## ***Lot 2 in RF Heating Building 15***

- Cooling water pipes for CCWS 2A – CCWS 2D and minor scope for Heat Rejection System (HRS)

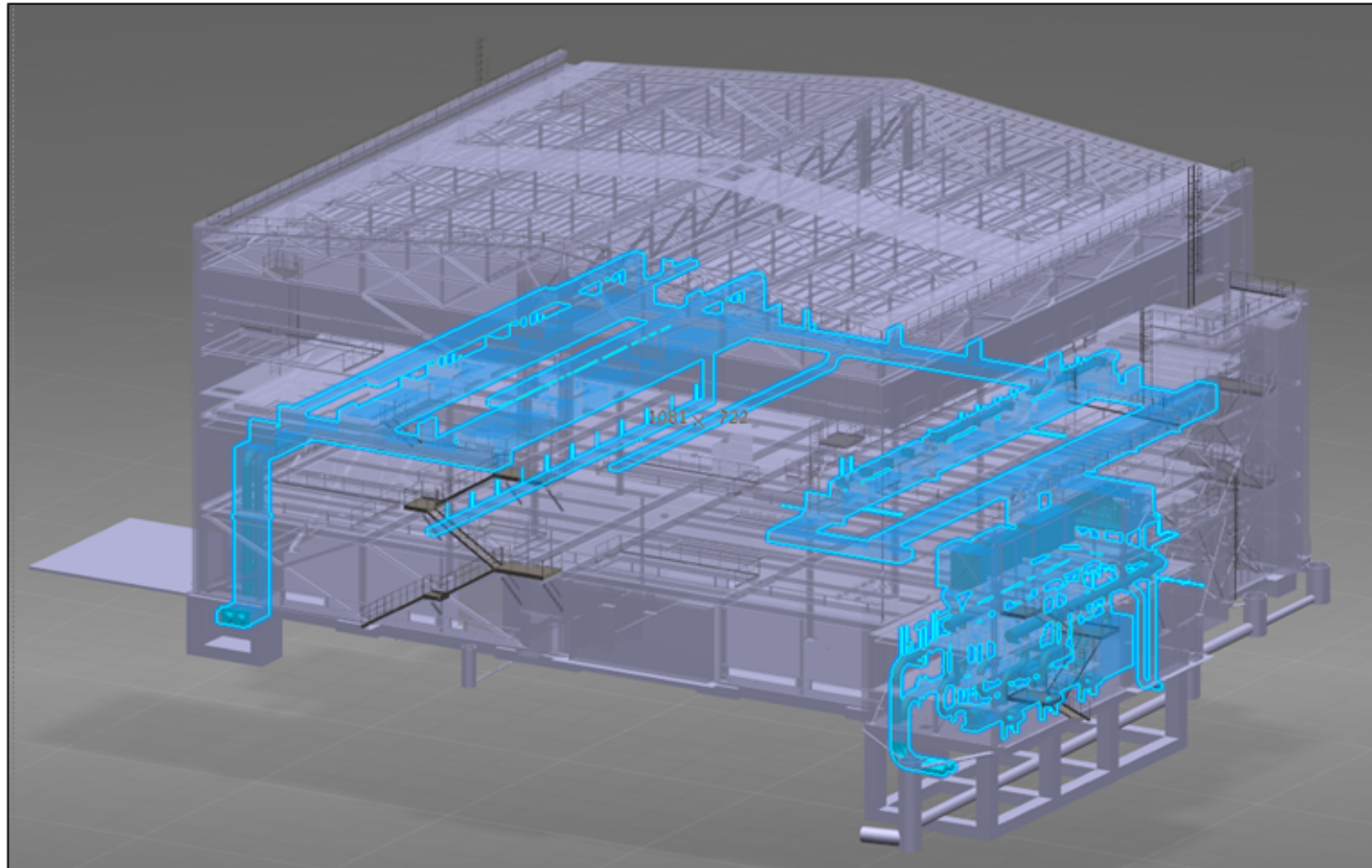

## ***Lot 2 in Diagnostic Building 74***

Cooling water pipes for CCWS 2A – CCWS 2B – CHWS H2 – CHWS H1

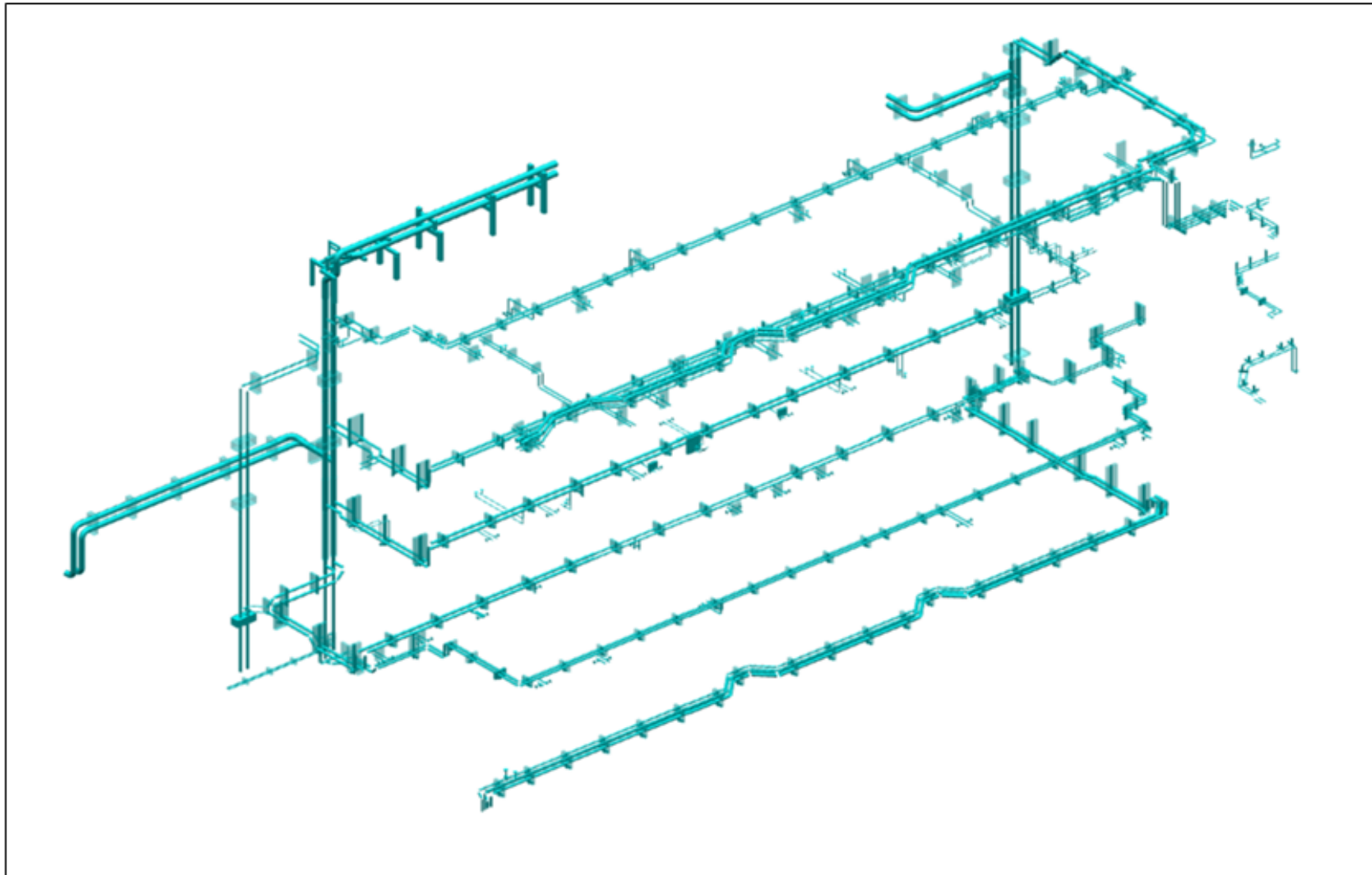



## ***Lot 3***

*Fueling lines, Vacuum lines, CCWS  
& CHWS, TBM lines in Building 11*

## Lot3 in Tokamak Building - B1 level

- Fueling (blue)
- Vacuum (grey)

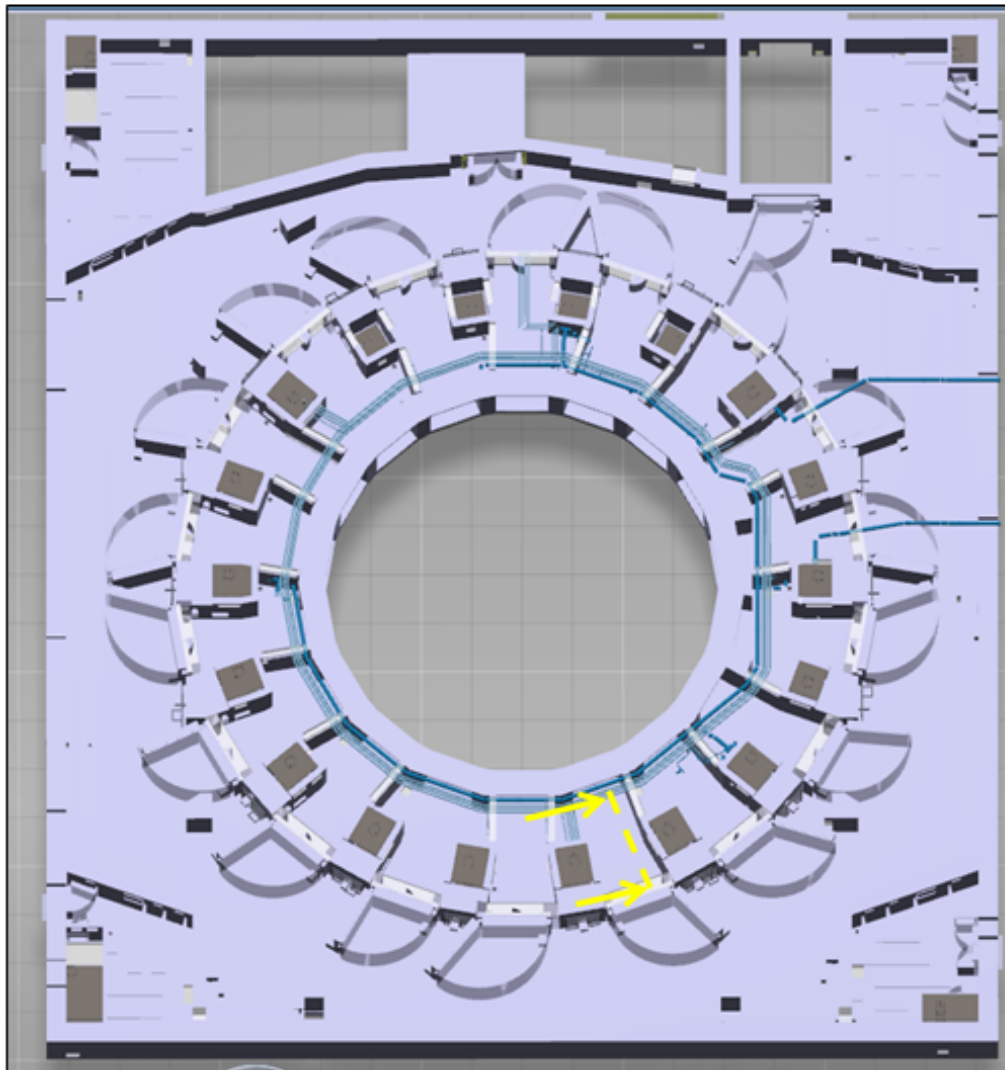

Port cell section view with full environment

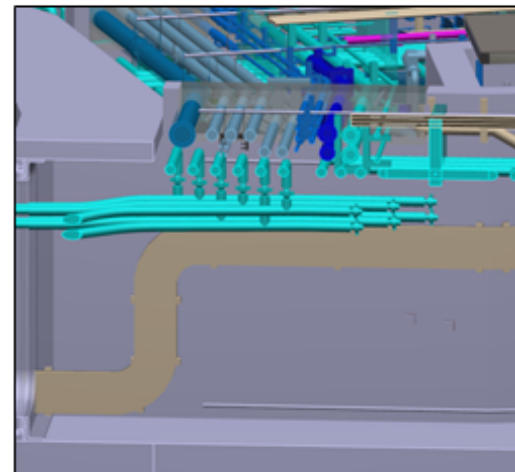

- Vacuum pipes
- Fueling pipes

Port cell section view with Early scope

### Lot 3 in Tokamak Building 11 - L1 level

- Vacuum pipes (grey)
- Cooling water pipes (light blue)
- TBM pipes (dark blue)

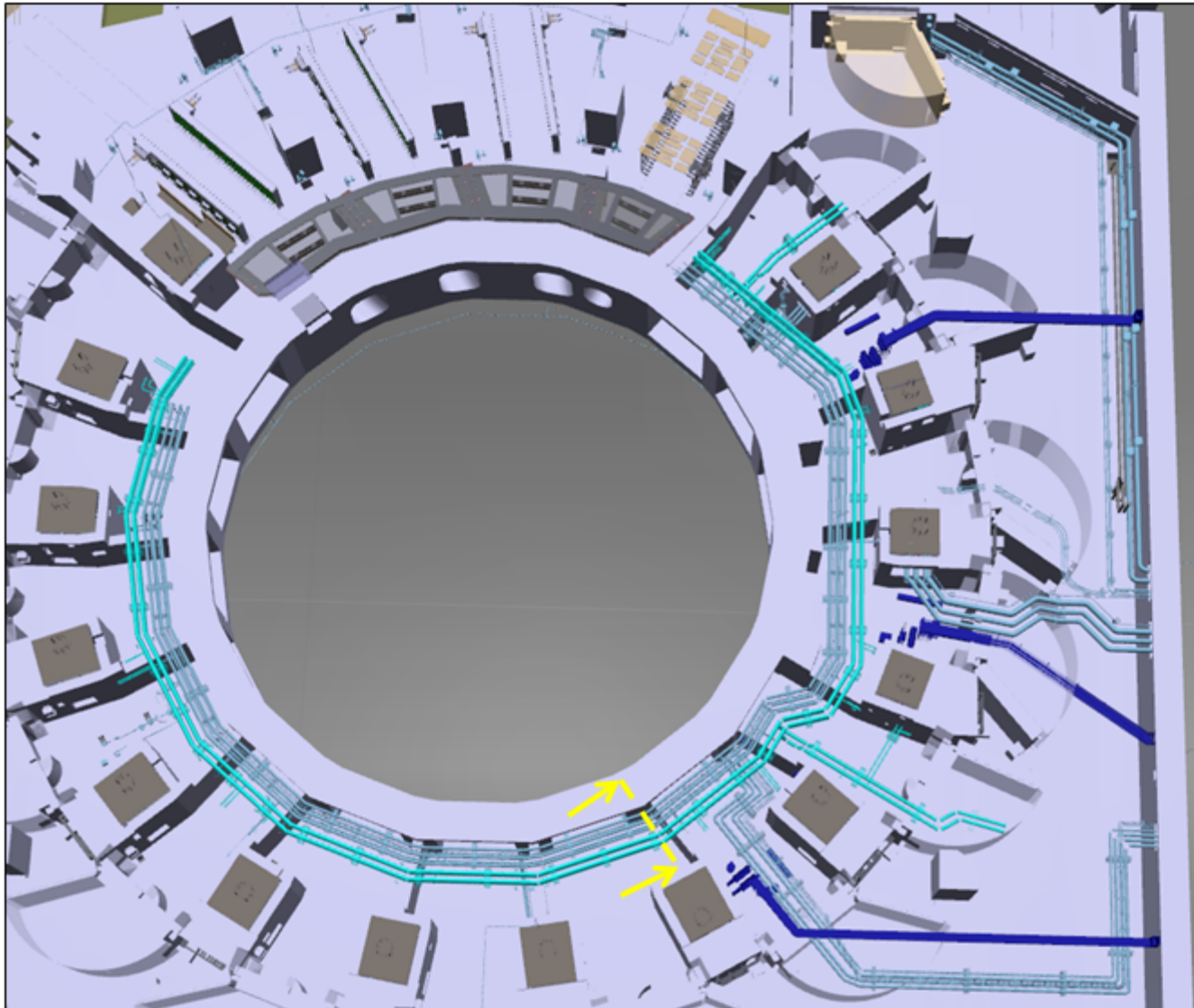

- Vacuum pipes
- Cooling water

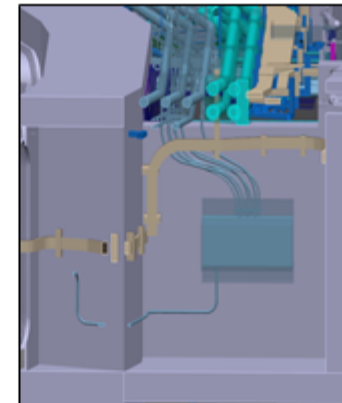

Port cell section view with full environment

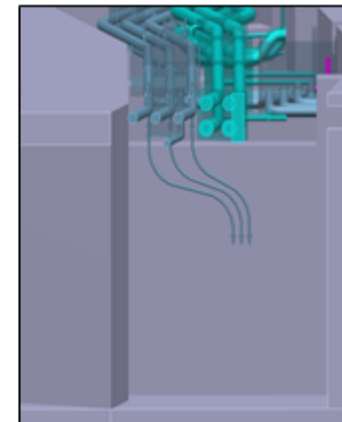

Port cell section view with Early scope

## Lot 3 in Tokamak Building 11 - L2 level

- Fueling (blue)
- Cooling water pipes (light blue)
- TBM pipes (dark blue)

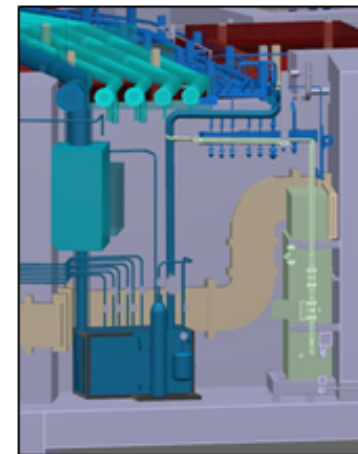
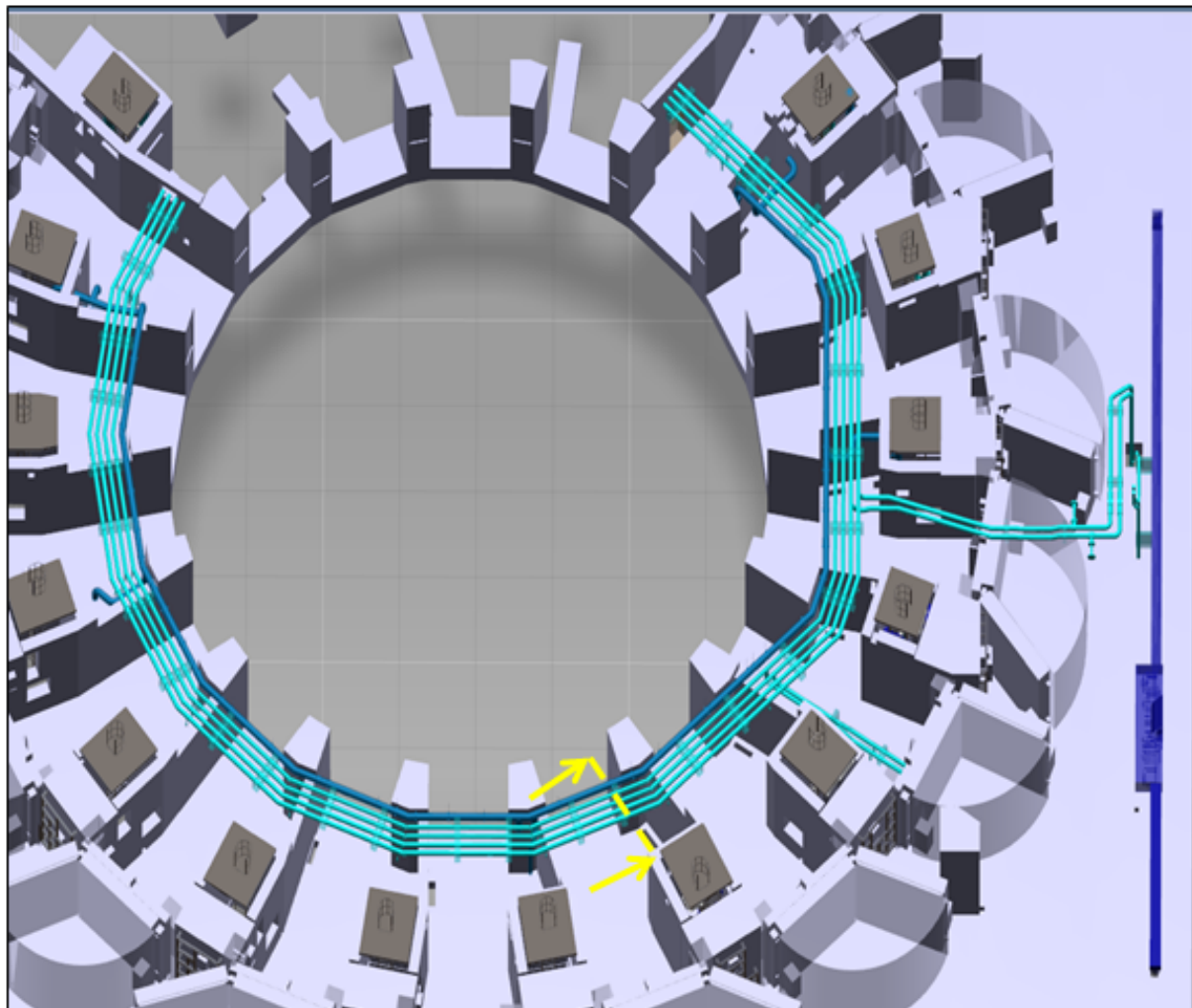

Port cell section view with full environment



Port cell section view with Early scope